

Features

- 36" minimum base cabinet width.
- Large/medium bowls.
- 9" (229 mm) depth provides generous workspace.
- Single faucet hole.
- An integrated faucet deck provides additional water containment.
- Smart Divide® feature offers a lower bowl divider that increases workspace versatility.
- Includes two bottom sink racks, walnut cutting board, and colander.
- Strainer sold separately.

Material

- KOHLER® enameled cast iron.

Installation

- Undermount installation kit not included.
- Undermount.

Recommended Products/Accessories

- K-6163 Right-Bowl Sink Rack
- K-6164 Left-Bowl Sink Rack
- K-8801 Sink drain and strainer with tailpiece
- K-8799 Sink drain and strainer basket
- K-11352 Disposal Flange with Stopper
- K-9000 P-Trap
- 1411886 Undermount sink kit 23"
- K-23726 Drain treatment
- K-23725 Cast iron cleaner

Included Components

Product consists of:

- K-6163 Right-Bowl Sink Rack
- K-6164 Left-Bowl Sink Rack
- K-6165 Cutting Board
- K-6166 Colander



Codes/Standards







ASME A112.19.1/CSA B45.2

KOHLER® Enameled Cast Iron Kitchen Sink Lifetime Limited Warranty

See website for detailed warranty information.

Available Colors/Finishes

Color tiles intended for reference only.

Color	Code	Description
	0	White
	FF	Sea Salt™
	96	Biscuit
	95	Ice™ Grey
	K4	Cashmere
	58	Thunder™ Grey
	7	Black Black™

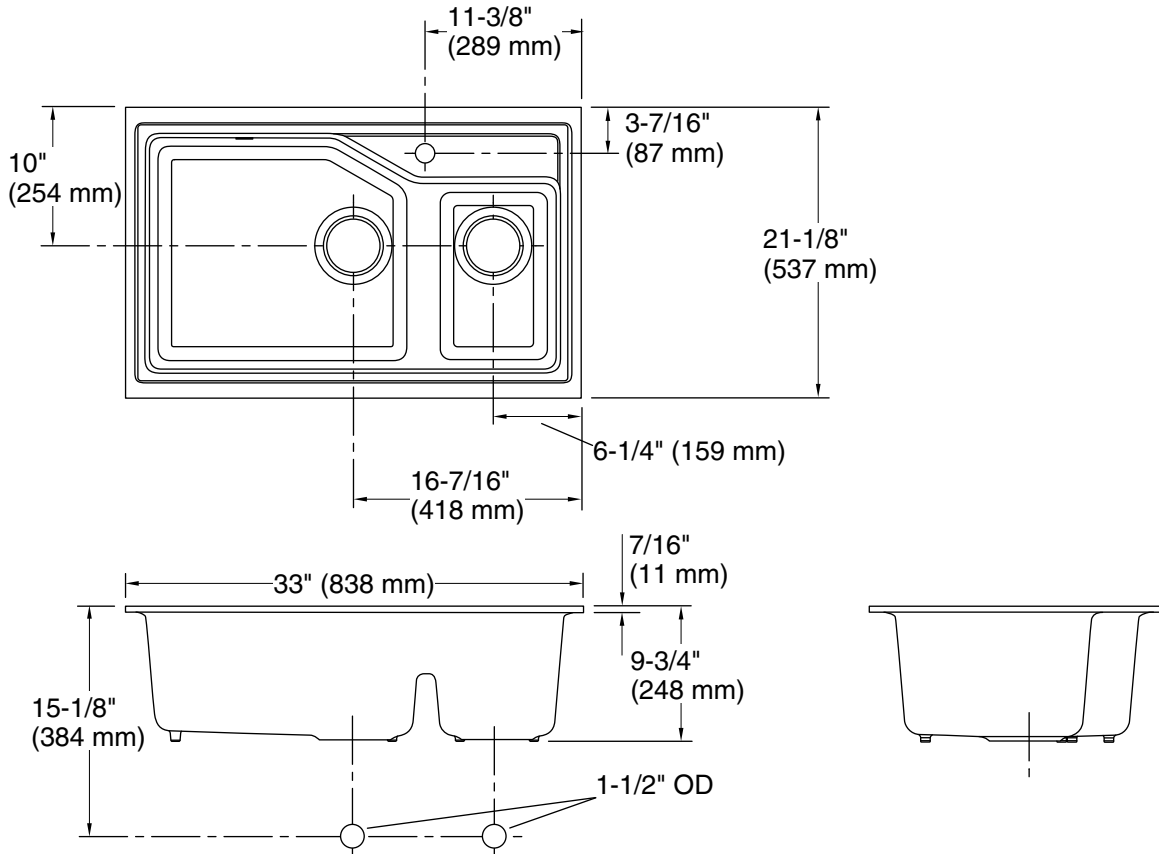

Technical Information

All product dimensions are nominal.

Installation:	Undermount
Min. base cabinet width:	36" (914 mm)
Bowl area (Left):	Length: 18-15/16" (481 mm) Width: 16-3/4" (425 mm) Bowl depth: 9" (229 mm) Water depth: 9" (229 mm)
Bowl area (Right):	Length: 8-11/16" (221 mm) Width: 13-1/2" (343 mm) Bowl depth: 9" (229 mm) Water depth: 9" (229 mm)
Number of deck holes:	1
Faucet hole(s):	1-3/8" (35 mm)
Drain hole:	3-7/8" (98 mm)
Template:	1106715-7, required, included

Notes

Install this product according to the installation instructions.

NOTICE: The countertop manufacturer or cutter must use the cut-out template provided with the product, or a current one provided by the Kohler Co. (Call 1-800-4-KOHLER.) Kohler Co. is not responsible for cut-out errors when the incorrect cut-out template is used.